



## International Journal of Current Research and Academic Review

ISSN: 2347-3215 Volume 2 Number 1 (January, 2014) pp. 148-163

[www.ijcrar.com](http://www.ijcrar.com)



### THE VIRGIN LIGHT?... (A new theory on source of Light)

M.Arulmani\* and V.R.Hema Latha

Superintending Engineer (E), BSNL Government of India, East Masi Telephone Exchange, Madurai – 625001 Tamilnadu, India

\*Corresponding author

#### KEYWORDS

Philosophy of “J-NADU”  
 Philosophy of “K-NADU”  
 Philosophy of “J-Radiation”  
 Philosophy of “J-Family”  
 Philosophy of “J-Cell”  
 Philosophy of “NAT, NATH, NATHAN”  
 Philosophy of word “Virgin”  
 Philosophy of word “Veil”  
 Philosophy of word “Age”  
 Philosophy of word “Ape”  
 Philosophy of word “Aceae”  
 Philosophy of word “Three domain of Life”  
 Philosophy of word “DARK” and “WHITE” flame  
 Philosophy of word “Virgin Particles”  
 Philosophy of word “J-Pulse”  
 Philosophy of word “Harmonics”

#### ABSTRACT

A scientific Research in this article focus that the whole universe and its matter contents shall be considered as **created initially** on origin by the beam of “**Virgin Light**” (or) “**White Flame**”. The virgin light shall also be called as “**J-Radiation**” emitted from the “**White Heart**” of “**Supernatural Creator**”. The J-Radiation shall also be considered as **Holy Spirit** in Biblical term.



The Beam of J-Radiation shall be considered composed of Billions of thin rays. **Each thin ray** shall be considered as representing “**each family**” of created matters and life. Further the Billions of initially created families of matters shall be considered as descended from a fundamental “**Virgin J-Family**”.

In Biology Taxonomy, the classification of various plants, animals and other non-biological family of matters etc shall be considered as descended from the “**Stem Cells**” of “**J-Family**”.

This research focus that in the expanding universe the J-family matters considered undergone wide **diversity** and three major genetic changes and produced thousands of **new families** in major three variation in new cosmic radiations.

The research focus during the cosmic radiation era the speed of light descended from “J-Radiation” shall be considered undergone three **variations in speed** due to growth of “**Sufficient Mass**” to the fundamental particles of fundamental J-family the **three family generation** light shall be considered as below

1st Nuclear age – “ $\gamma$  - Family” 2nd Nuclear age – “ $\beta$  - Family” 3rd Nuclear age – “ $\alpha$  - family”

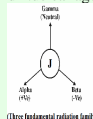

This research emphasize that the three family of cosmic radiations shall be considered genetically variant due to variation in **space, time, gravity** of universe in three phases of “**Nuclear age**”. The Philosophy of space, time, gravity shall be considered closely associated with characteristics of SUN, EARTH, MOON.

Time – Sun, Gravity – Earth, Space - Moon



It is focused that the so called “**Speed of Light**” stipulated in two “**Einstein’s theory**” in Quantum physics (ie) special relativity theory, general relativity theory shall be considered as “**3<sup>rd</sup> generation light**” which is capable of traveling at the maximum speed of **299,792,458 meter/second**. The J-family radiation shall be considered as capable of **flying** constantly at the maximum speed of “ $3.0 \times 10^8$  meter/second”.

It is further focused that the three major nuclear age shall be considered as evolved due to variations in relative position of **SUN, EARTH, MOON** in the universe in three geological periods.

It is emphasized that the observations made by **Einstein sir** in his “**Relativity theory**” shall be considered as due to variation in “relative position” of **SUN, EARTH, MOON** which results in three major genetic cosmic variation of space, time and gravity. The impact of three geological age space, time, and gravity shall be narrated as below:



“*Space, Time, Gravity shall be considered as three genetic variation parameters of universe due to impact of generation of three cosmic families of  $\alpha, \beta, \gamma$  radiations.*”

- Author

### Introduction

The scientific study focus that the fundamental light source to the Earth is

“**SUN**”. The radiation emitted by the chromospheres of the sun at around about

6000°K in the visible region of Electromagnetic spectrum and roughly 44% of sun light energy that reaches the Earth as **visible light**.

In this research it is focused that the J-Radiation shall be considered as the most fundamental **primary source of light** and all others are secondary cosmic radiations. The J-Radiation shall be considered as the **“First born”** matter of universe “Virgin Light” (White flame) virgin light shall mean **“absolutely pure”** and **“white”** and **FLYING** at the highest speed of all matters of universe irrespective of medium.

The J-Radiation shall be considered as composed of three-in-one fundamental neutrino particles **“PHOTON”** **“ELECTRON”** **“PROTON”** called as **“Virgin Particles”**. The neutrino particles shall be considered having **“Zero mass”** and having definite **WAVE PROPERTY** charge polarity, electric, magnetic, optic properties.

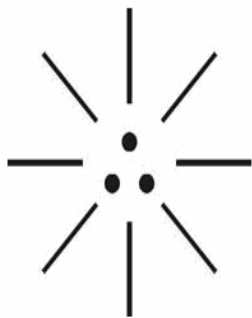

**(Fundamental Neutrinos)**

*“The three neutrino particles shall be considered as fundamental cell particles (J-CELL) required for subsistence of life and matters”* - Author

### **Previous Publication**

The philosophy of origin of first life and human, the philosophy of model Cosmo

Universe, the philosophy of fundamental neutrino particles have already been published in various international journals mentioned below. Hence this article shall be considered as **extended version** of the previous articles already published by the same author.

1. Cosmo Super Star – IJSRP, April issue, 2013
2. Super Scientist of Climate control – IJSER, May issue, 2013
3. AKKIE MARS CODE – IJSER, June issue, 2013
4. KARITHIRI (Dark flame) The Centromere of Cosmo Universe – IJIRD, May issue, 2013
5. MA-AYYAN of MARS – IJIRD, June issue, 2013
6. MARS TRIBE – IJSER, June issue, 2013
7. MARS MATHEMATICS – IJERD, June issue, 2013
8. MARS (EZHEM) The mother of All Planets – IJSER, June issue, 2013
9. The Mystery of Crop Circle – IJOART, May issue, 2013
10. Origin of First Language – IJIRD, June issue, 2013
11. MARS TRISOMY HUMAN – IJOART, June issue, 2013
12. MARS ANGEL – IJSTR, June issue, 2013
13. Three principles of Akkie Management (AJIBM, August issue, 2013)
14. Prehistoric Triphthong Alphabet (IJIRD, July issue, 2013)
15. Prehistoric Akkie Music (IJST, July issue, 2013)
16. Barack Obama is Tamil Based Indian? (IJSER, August issue, 2013)
17. Philosophy of MARS Radiation (IJSER, August 2013)

18. Etymology of word “J” (IJSER, September 2013)
19. NOAH is Dravidian? (IJOART, August 2013)
20. Philosophy of Dark Cell (Soul)? (IJSER, September 2013)
21. Darwin Sir is Wrong?! (IJSER, October issue, 2013)
22. Prehistoric Pyramids are RF Antenna?!... (IJSER, October issue, 2013)
23. HUMAN IS A ROAM FREE CELL PHONE?!... (IJIRD, September issue, 2013)
24. NEUTRINOS EXIST IN EARTH ATMOSPHERE?!... (IJERD, October issue, 2013)
25. EARLY UNIVERSE WAS HIGHLY FROZEN?!... (IJOART, October issue, 2013)
26. UNIVERSE IS LIKE SPACE SHIP?!... (AJER, October issue, 2013)
27. ANCIENT EGYPT IS DRAVIDA NAD?!... (IJSER, November issue, 2013)
28. ROSETTA STONE IS PREHISTORIC “THAMEE STONE” ?!... (IJSER, November issue, 2013)
29. The Supernatural “CNO” HUMAN?... (IJOART, December issue, 2013)
30. 3G HUMAN ANCESTOR?... (AJER, December issue, 2013)
31. 3G Evolution?... (IJIRD, December issue, 2013)
32. God Created Human?... (IJERD, December issue, 2013)
33. Prehistoric “J” – Element?... (IJSER, January issue, 2014)
34. 3G Mobile phone Induces Cancer?... (IJERD, December issue, 2013)
35. “J” Shall Mean “JOULE”?... (IRJES, December issue, 2013)
36. “J”- HOUSE IS A HEAVEN?... (IJIRD, January issue, 2014)
37. The Supersonic JET FLIGHT-2014?... (IJSER, January issue, 2014)
38. “J”-RADIATION IS MOTHER OF HYDROGEN?... (AJER, January issue, 2014)
39. PEACE BEGINS WITH “J”?... (IJERD, January issue, 2014)

### Hypothesis

1. The entire “**Cosmo Universe**” shall be considered as created by “**supernatural human**” “The dwelling place of supernatural human shall be called as “**K-NADU**”. **K-NADU** shall mean dark house, completely filled with full of “Dark matter”, “Dark Energy” derived from “Dark flame” required for creation process and sustainability of universe. The “**K-NADU**” shall also be called as “**KARUNAI ILLAM**” and Dark flame shall be called as “**KARUNAI**”. The **K-Nadu** shall be considered as composed of **THREE-IN-ONE** region and having the foundation supported by **SUN, EARTH, MOON** and under strong **gravitational force** influenced by dark flame. Further the three regions of the **Cosmo Universe** shall be considered as separated by thin membrane called “**VEIL**”. The Philosophy of **VEIL** shall be defined within the following scope.

- (i) The **VEIL** shall mean absolutely pure and transparent media between two regions
- (ii) **VEIL** shall mean as boundary of radiation equilibrium
- (iii) **VEIL** shall mean as equivalent to cell wall in biology.
- (iv) **VEIL** shall mean highly hot radiation also called as akkie, akkini.

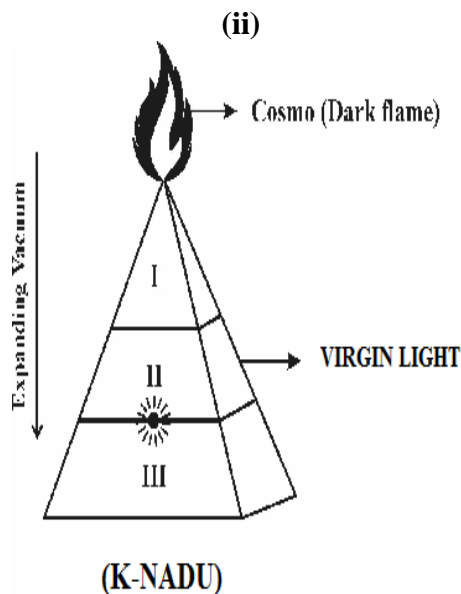
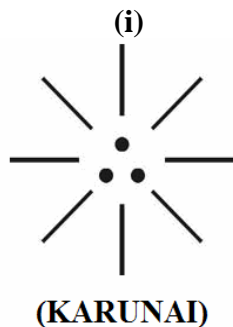

Region I – Perfect vacuum region (Anti-Neutrinos radiation)  
 Region II – Partial vacuum region (Neutrinos radiation)  
 Region III – Observable Vacuum region (EMR radiation)

The Cosmo region shall be considered as **highly cold region** emitting dark radiation. Region-III shall be considered as **highly hot region** with three grading level (i.e. Tesla region, Newton region, Einstein region) .

2. The name of the creator shall be called by name as “NATHAN”. Nathan shall mean “FATHER”. The Father shall be considered created everything through right

and left hands and “J-Radiation” emanated from the “Heart”. The heart of Nathan shall also be called as “J”.

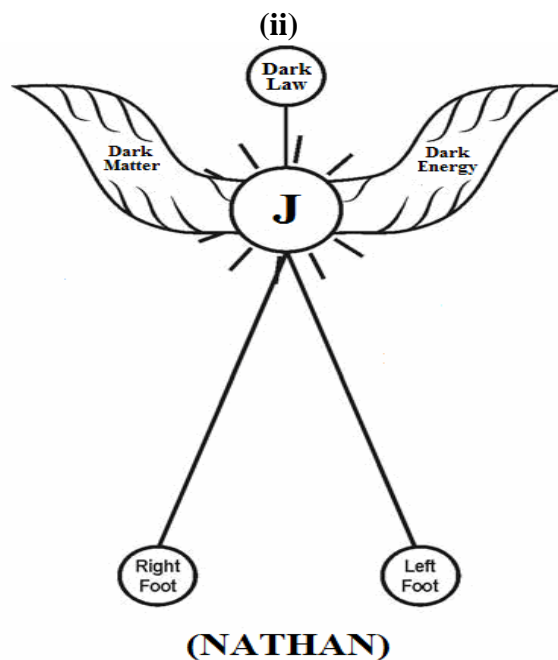
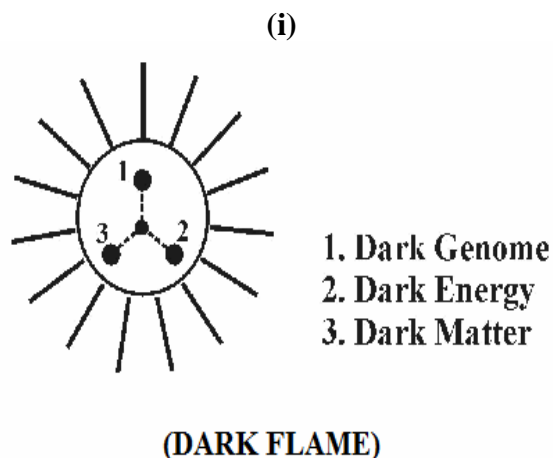

The philosophy of “NATHAN” shall be defined within the following scope.

- (i) NATHAN shall mean “CREATOR”
- (ii) NATHAN shall mean “GOD”
- (iii) NATHAN shall mean “FATHER”
- (iv) NATHAN shall mean “POPE” OF “K-NADU”
- (v) NATHAN shall mean heart filled with “VIRGIN LIGHT”

3. The virgin light emanated from the heart shall be considered as having creation effect of life and matters. The beam of virgin light shall be considered composed of Billions of “thin ray” called “NATH”. NATH shall mean “Natural Nursery Plant”. Each NATH shall be considered representing naturally created family of life and matters.

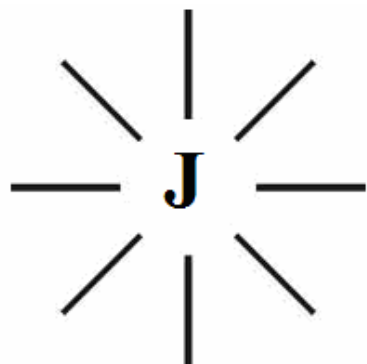

**(J-NATH)**

4. Each “Nath” (thin ray) shall considered composed of “three-in-one” fundamental particles PHOTON, ELECTRON, PROTON having sustained oscillation. These particles shall be called as “Virgin cell” called as “J-CELL” and considered as members of “VIRGIN NATHAN FAMILY”.

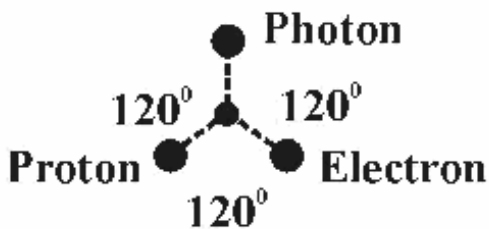

**(VIRGIN CELL)**

5. Each member of virgin family shall be considered dwelling in Three-in-one chamber separated by “VEIL”. VEIL shall

mean small thin tissue membrane or Neutrino Cell wall.

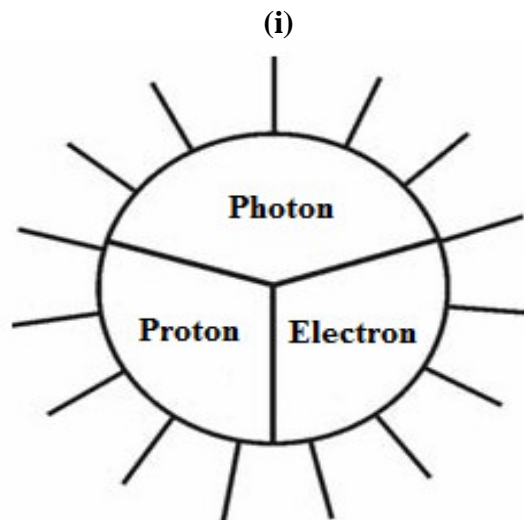

**(Virgin Nathan Family)**

(ii)

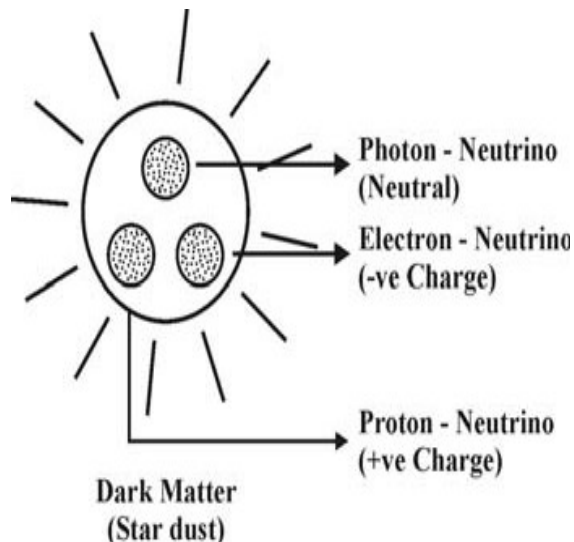

6. The three members of the virgin family shall be considered as having definite gender and considered as FATHER, MOTHER, INFANT. Alternatively the three particles in Neutrino family shall be considered in human equivalent as follows.

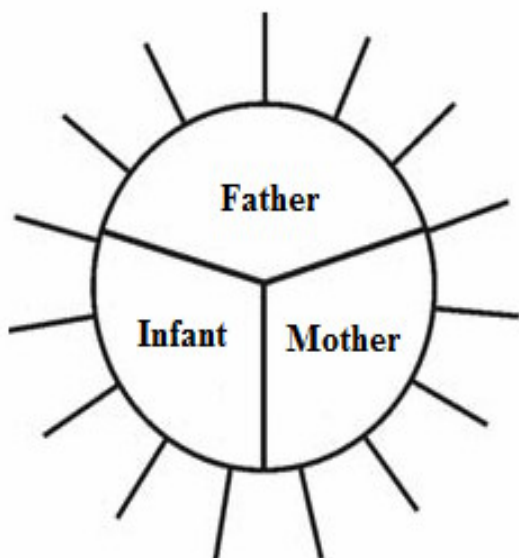

**(Virgin Nathan Family)**

The members of virgin Nathan family shall be considered having definite charge polarity, optic, electric, magnetic property.

- (i) Photon – “**FATHER**” (Sun)
- (ii) Electron – “**MOTHER**” (Earth)
- (iii) Proton – “**INFANT**” (Moon)

In medical equivalent the members of the virgin family shall be represented as below:

- (i) FATHER – “**RNA**” (Photon)
- (ii) MOTHER – “**HORMONE**” (Electron)
- (iii) INFANT – “**DNA**” (Proton)

7. During creation process the NATHAN shall be considered have sung “SONG” (soul music) called “AMEN”. AMEN shall mean Absolute silence called “WHITE SOUND” AMEN shall be considered as “Divine Virgin Lullaby” (or) “J-Lullaby” to keep the created Infant always under perfect “PEACE” with closed eyes.

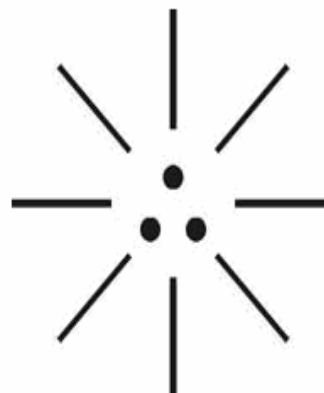

**(AMEN)**

8. During the expanding universe the three family of radiations shall be considered evolve and during different Nuclear age with different genetic structure from fundamental “VEIL”. VEIL shall mean **Virgin Light** or White Flame. VEIL shall also be called as AKKIE, AKKINI. Alpha, Beta, Gamma shall be considered as three family of cosmic radiation descended from VEIL with definite angular displacement.

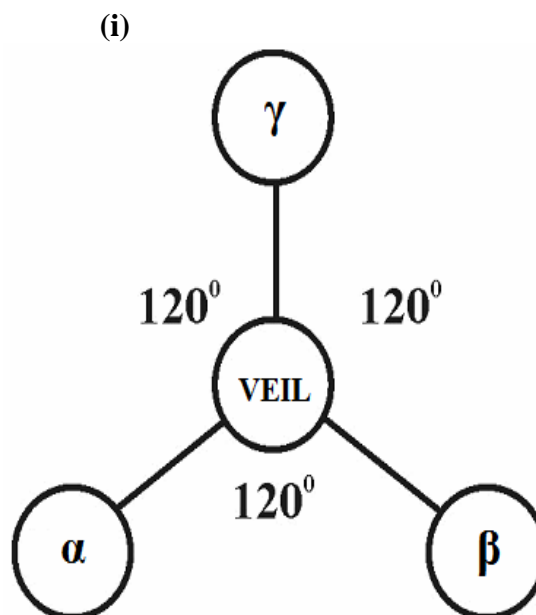

**(Three Nuclear Age)**

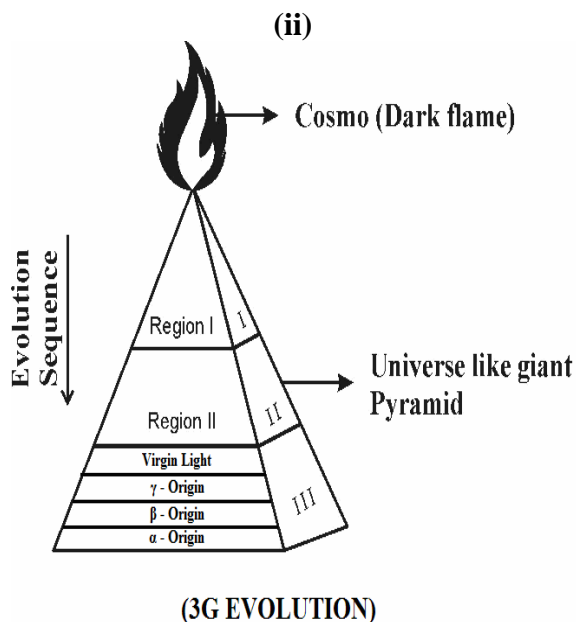

- i. 1st generation nuclear age -  $\gamma$  - family
- ii. 2<sup>nd</sup> generation nuclear age -  $\beta$  - family
- iii. 3<sup>rd</sup> generation nuclear age -  $\alpha$  - family

9. The Philosophy of Ray, Radiation shall be considered as **PULSE** called as **J-RAY** represented in tiny dot lines. It is focused that the Philosophy of UV ray, RF ray, IR ray shall be considered as three **ray families** descended from distinguished **RAY LENGTH**.

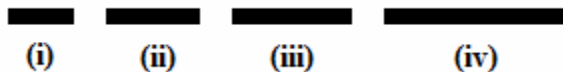

- (i) J-Ray – Origin
- (ii) UV-Ray – 1<sup>st</sup> Generation Radiation
- (iii) RF-Ray – 2<sup>nd</sup> Generation Radiation
- (iv) IR-Ray – 3<sup>rd</sup> Generation Radiation

10. The Philosophy of **WAVE** and **HARMONICS** might be derived from the Philosophy of **J-WAVE**. It is focused that in the early Universe the J-Radiation shall be considered having property of **PULSE** rather than wave form. It is focused that the Philosophy of **SINE WAVE** stipulated by **EINSTEIN** in electromagnetic wave theory

shall be considered as 3<sup>rd</sup> Generation harmonic wave to the fundamental J-Wave (J-Pulse).

- (i) J-Wave – Origin
- (ii) Triangular Wave – 1<sup>st</sup> Generation Harmonics
- (iii) Square Wave – 2<sup>nd</sup> Generation Harmonics
- (iv) Sine Wave – 3<sup>rd</sup> Generation Harmonics

11. In quantum physics Tesla, Newton, Einstein shall be considered as Trinity organs of creator **NATHAN** and three families of universal law. In expanding Universe there are so many complicated theories about **space, time, gravity**. It is emphasized in this research article that space, time, gravity shall be considered as **THREE-IN-ONE** universal parameter and considered interdependent to one another. Because of interdependency the three parameters shall be considered consistently variant in three nuclear age and geological period. It is focused that the Philosophy of Space, Time, Gravity shall be considered closely associated with characteristics of **SUN, EARTH, MOON**.

In fact it is focused that Tesla, Newton, Einstein shall be considered as Trinity organs of the creator Nathan i.e. Right hand of Nathan is Einstein, Left hand of Nathan is Newton, brain of Nathan is Tesla. Alternatively Einstein shall be viewed like proton neutrino (Moon), Newton shall be viewed like electron neutrino (Earth), Tesla shall be viewed like photon neutrino (Sun). The heart of Nathan shall be considered as emitting **VIRGIN LIGHT** when the sun begins to operates it **clock** through **inner core of Sun**. Further it is hypothesized that the inner core clock of Sun completes one cycle in entire cosmological period and the position of clock shall make impact on

evolution of **three generation matters** on initial creation made by **Nathan**.

It is further hypothesized that SUN, EARTH, MOON never revolve any planets and it rotate only **on its axis** the various cosmological routine environmental changes shall be considered happening due to **relative position** of inner core and outer core of SUN, EARTH, MOON.

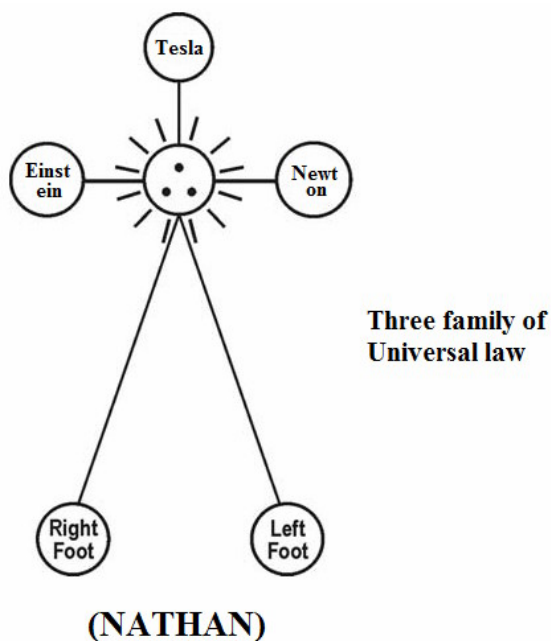

It is speculated that in the early Universe the Nathan was highly stable and **STANDSTILL** due to symmetry in relative position of SUN, EARTH, MOON. During expanding Universe due to impact of Sun clock, the relative position of SUN, EARTH, MOON become variant in three nuclear age and consistently become asymmetric. Due to this asymmetry the Nathan started **DANCING** by moving the legs, hands, head for counter balance to make **“UNIVERSAL EQUILIBRIUM”**. Due to this fact of asymmetry and imbalance the following cosmological changes shall be considered happening consistently as follows.

(a) On creation the prehistoric human shall be considered having only three chromosome derived from three fundamental neutrinos. Subsequently during three nuclear age three human families might have been evolved and attained to the stage of 46 chromosome. Similarly the prehistoric human on creation might have had only single type blood AB and during the course of time four type blood might have been evolved within three families of human.

(b) The prehistoric human might have had standard heart pulse of around 60ppm. During the course of time the standard pulse rate might have been increased to 72ppm. It is speculated that the standard pulse rate may be shifted to 90ppm by 3000AD.

(c) In the early Universe the natural frequency of oscillation of Earth might be **zero** and subsequently deviated to 7.83Hz which is observed by Schumann resonance. Scientists focus that the Schumann resonance is consistently increasing and is expected to reach 12Hz by 2100.

(d) In prehistoric time the axis of rotation of earth might be zero and subsequently might be deviated to present level of axial angle of 23.5°. Astronomers confirmed that moon is movin away from earth 3.8cm per year.

The prehistoric and modern time relative position of SUN, EARTH, MOON is indicated as below. MARS planet shall be considered as heart of Nathan and source of Virgin Light.



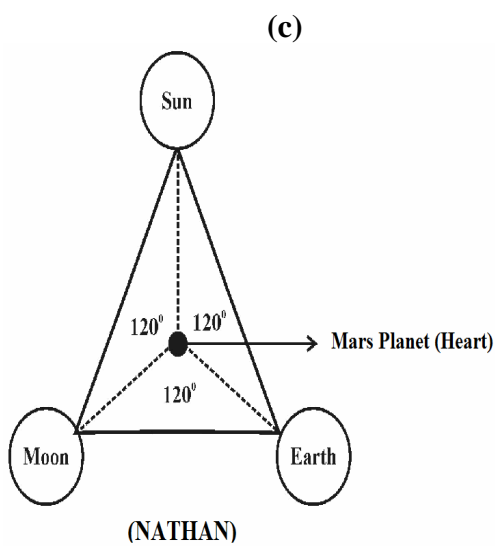
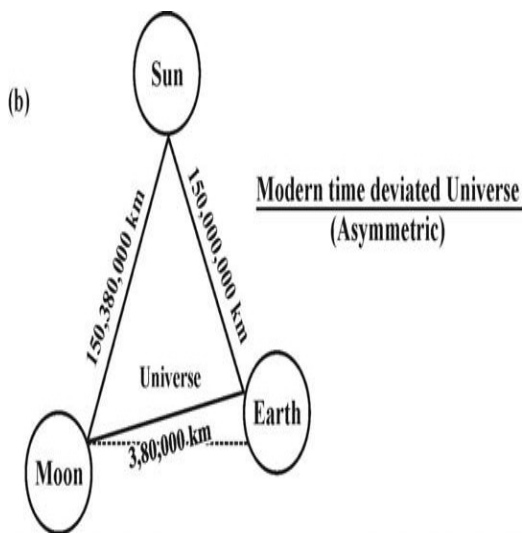
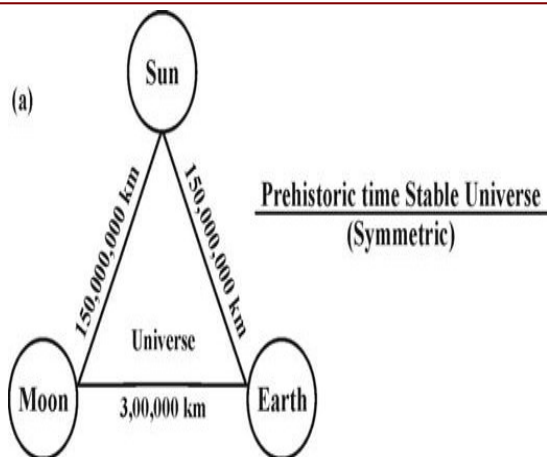

12. During expanding universe three genetically varied Human family from ancestral “NATHAN FAMILY”

- i. 1<sup>st</sup> generation – “ANGEL family”
- ii. 2<sup>nd</sup> generation – “DRAVIDIAN family”
- iii. 3<sup>rd</sup> generation – “ARYAN family”

13. During expanding universe three genetically varied “HCNO” family which is considered as responsible for impact on variant Space Time, gravity parameters of Universe. H-NATH shall mean fundamental HCNO.

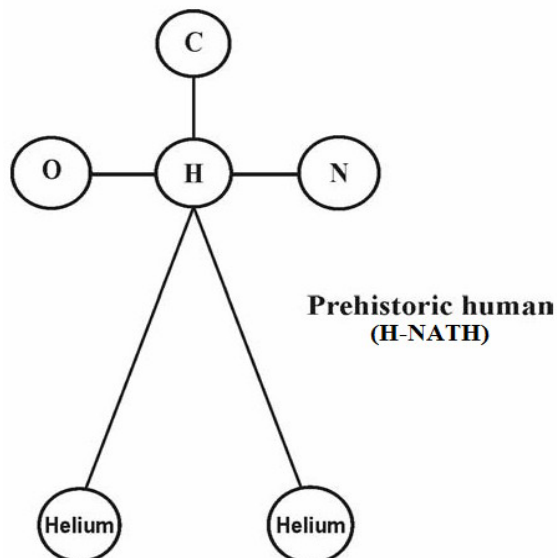

14. In the expanding universe the three fundamental source of Energy (ie) SOUND ENERGY, LIGHT ENERGY, HEAT ENERGY shall be considered as three families of Energy descended from J-Family “White Energy”.

- i. Sound energy - 1<sup>st</sup> generation family
- ii. Light energy - 2<sup>nd</sup> generation family
- iii. Heat energy - 3<sup>rd</sup> generation family

The three families of Energy shall be considered as evolved from originally created “**VIRGIN LIGHT**” (J-Radiation) descended from “**NATHAN FAMILY**”, “**Absolute white Energy**”.

15. In the expanding Universe the three fundamental branches of Science (ie) Mathematical Science, chemical science, physical science shall be considered as three families of “**Natural Science**” (or) “**Pure Science**”. Pure Science shall mean study of fundamental particles.

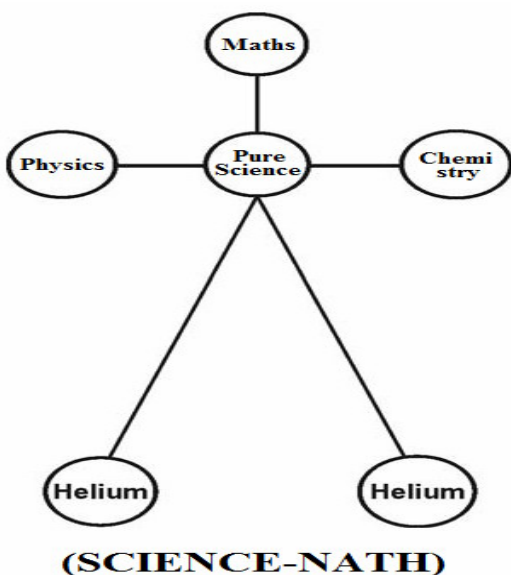

The philosophy of Natural Science, pure science shall be considered derived from the philosophy of “**NATH**” (OR) “**J-SCIENCE**” NATH shall mean fundamental scientific study related to virgin particles photon, electron, proton.

16. The philosophy of “**NAT**”, “**NATURE**”, “**NATION**” shall be considered as derived from the philosophy of “**NATH**”, “**NATHAN**” “**NADU**”. NADU shall mean prehistoric created land for dwelling of life. “**MARS**” shall be considered as the prehistoric “**J-NADU**”. **CHOLA NADU**, **PANDYA NADU**, **CHERA NADU** shall be considered as the

three “**NADU FAMILY**” descended from fundamental J-NADU in three geological periods.

**Hypothetical Narration**

**a) Philosophy of Lord GOD?...**

The English word God is generally understood as the creator and ruler of universe and considered as sources of all moral authority. It is focused that the philosophy of GOD might be derived from the philosophy of **NAT**, **NATH**, **NATHAN**.

- i.NAT shall mean “**LIVE**”
- ii.NATH shall mean “**INFANT (OR) NURSERY**”
- iii.NATHAN shall mean “**SUPER HUMAN**”

**b) Philosophy of MYTH?...**

The superhuman NATHAN shall be considered as highly mystic. The philosophy of Myth, Mythology might be derived from the philosophy of NATH.

**c) Philosophy of MATH?...**

The English word MATH is related to the study of mathematics related to empirical analysis of natural matters. It is focused that the philosophy of MATH might be derived from the philosophy of “**NATH**”. NATH shall mean Natural science (or) “**NATHAN LOGIC**” or “**J-Logic**”.

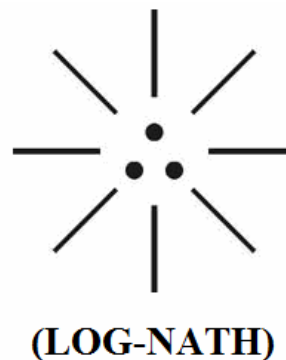

**d) Philosophy of Neutrino?...**

The philosophy of so called various neutrino particles such as proton, MUD, electron, supernovae etc. might be derived from the philosophy of NATH. NATH shall mean most fundamental **“White Particles”** emanated from Heart of NATHAN called as White flame (J-Radiation) or **“VIRGIN LIGHT”**. The so called **“GOD Particle”** stipulation in Quantum physics might be derived from the philosophy of **“Virgin particles”** (J-particles). The etymology of **“Neutrino”** might be derived from the phonetic sound of NAT, NATH.

**e) Philosophy of word NATURE, NATION?...**

The philosophy and etymology of English Word NATURE, NATION might be derived from the phonetics of NAT, NATH, NADU.

**f) Philosophy of RAY, RADIATION, LIGHT?...**

The philosophy of RAY, RADIATION, LIGHT might be derived from the philosophy of NATH. The so called **LIGHT, SINE WAVE** stipulated in **Einstein theory** shall be considered as Third Generation matter descended from **VIRGIN LIGHT (J-PULSE)**.

**g) Philosophy of Rainbow, Corona?...**

The philosophy of Rainbow, Corona and dispersed colour elements shall be considered as subspecies radiation to three fundamental family of radiation. Further it is focused that the so called lunar bow, moon bow, fog bow etc shall be considered as Third Generation radiation descended from **VIRGIN LIGHT**.

**h) Philosophy of Lightning & Electromagnetic radiation?...**

It is focused that the philosophy of Electromagnetic radiation (EMR) and Electromagnetic spectrum of UV, RF, IR regions shall be consideration as species to fundamental ancestral **“VIRGIN LIGHT”** (J-Radiation). The speed of Virgin light ( $3 \times 10^8$  meter/sec) shall be considered as the highest speed of all matters of **“Material Universe”** (Region III) and Virgin Light shall be considered as **“MOTHER”** of all  $\alpha$ ,  $\beta$ ,  $\gamma$  family. **LIGHTNING** shall be considered as the slightly impure light compared to **absolutely pure white virgin light**.

**i) Philosophy of Schumann Resonance?...**

The philosophy of Schumann resonance observed in Ionosphere region might be derive from the philosophy of **“AMEN”**. AMEN shall means Divine sound sung by creator NATHAN during creation process. The AMEN shall be considered as **“White Sound”** (or) **“J-Sound”** (or) **“Virgin-Sound”** meaning Absolute silence. The J-Sound shall also mean **“Absolute Peace”** and the state of **“Closed eye”**.

**j) Philosophy of child growth in mother’s womb?...**

The philosophy of three Trimester growth of child within mother’s womb might be derived from the philosophy of NATHAN logic.

- i) Stem cell(J-cell) – Nathan family(J-Family)
- ii) Fetus (1<sup>st</sup> Trimester) -  $\gamma$  - family
- iii) Infant(2<sup>nd</sup> Trimester) -  $\beta$  - family
- iv) Child(3<sup>rd</sup> Trimester) -  $\alpha$  – family

**k) Philosophy of Age, Triassic?...**

The Philosophy Age, Triassic might be derived from the philosophy of three geological variations concerned with relative position of SUN, EARTH, MOON. "AGE" shall mean geometric symmetry of SUN, EARTH, MOON pronounced as "AKKIE".

Stone-Age, Bronze-Age, Copper-Age shall be considered as three families of geological period derived from fundamental geological origin "AGE".

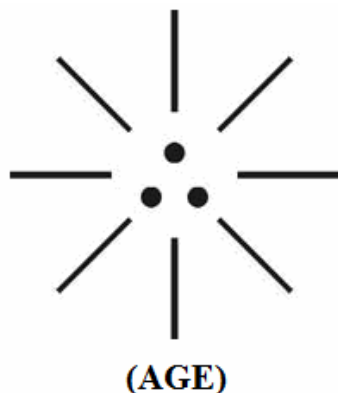

**l) Philosophy of "Aceae"?...**

Case study shows that the word Aceae denotes "Orders and classification" of families in Botany. Further the word **acea**, **aceus** is used as suffix and used with technical combination. especially in Biological terms "Pertains", "belonging to", "Of the nature" "Characteristics of".

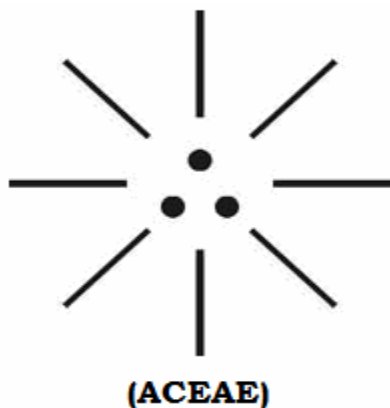

It is focused that the philosophy of word Acea, Aceae, aceus might be derived from the philosophy of ancestral "Nathan Family" from originally Created "NATH".

**m) Philosophy of word "APE"?...**

Case study shows that "APE" is considered as a large primate that lacks tail including **Gorilla, Chimpanzee, Oranguttan and Gibbons**.

It is focused that the word Ape shall be considered as one of Billons of NATH (J-Radiation) emitted from Heart of "NATHAN" (ie) Ape shall mean fundamental created Nath of Monkeys family. It is focused that in the spectrum of created NATH the genetic thin fiber of J-Radiation might be very close in the "NATH SPECTRUM". The Chimpanzee, Gorilla, Oranguttan shall be considered as distinguished different sub families of "APE-NATH" evolved in three different geological and Nuclear Age.

- i)"Chimpanzee"(genus pan)
- ii)"Gorilla"(genus gorilla)
- iii)"Oranguttan"(genus pango)

**n) Philosophy of three Domain of Life?...**

The philosophy of three domain of Life might be derived from the philosophy of evolution and genetic changes in three Geological, Nuclear Age. Bacteria, arhaea, eukaryotes shall be considered as thee distinguished family descended from Nathan family.

- i)"Bacteria" (Blue) - **1<sup>st</sup> Nuclear age**
- ii)Archaea (Green) - **2<sup>nd</sup> Nuclear age**
- iii)Eukaryotes (Red) - **3<sup>rd</sup> Nuclear age**

**o) Case study on Quantum physics?...**

- (i) *Einstein was wrong: Aether exists*  
- Nikola Tesla
- (ii) *Einstein's theory have fooled the world for almost 100 years*  
- Ozo
- (iii) *Neutrinos travel one nanosecond faster than speed of Light.* - OPERA experiment
- (iv) *The laws of physics wouldn't change; only the universal constants.* - Grossman
- (v) *Einstein may not be wrong; He probably began his experiment in Region-III vacuum; But Aether exists.*  
- Author

**p) Case study on BIBLE:**

It is focused that the **“Heavenly Further”** shall be considered as creator and God. The so called **“Holy Spirit”** shall be considered as three domain of initially created Life and matter. Each ray of Holy spirit shall be considered as genus of Billions of initial creation. The human genus shall be considered as **“J-Nath”**. **“J-Nath”** shall also be called as **Ist “POPE” of “K-NADU”**.

In the expanding Universe the J-Nath family might have attained diversity and undergone three major **“genetic change”** in three geological Nuclear Age

- i) **“J-Nath”** - **“NATHAN”** Family(J-Radiation)
- ii) **“ADAM”** - **“ANGEL”** Family(  $\gamma$  - Radiation)
- iii) **“JACOB”** (ISRAEL)-**“NOAH”** Family( $\beta$ - Radiation)
- iv) **“JESUS”** - **“CHRIST”** Family(  $\alpha$  - Radiation).

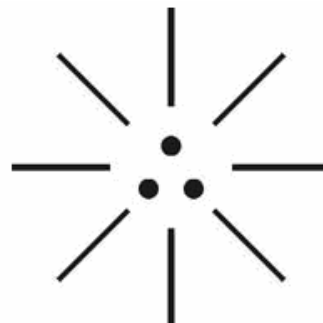

**(TRINITY FAMILY)**

The Christ family shall be considered as 3<sup>rd</sup> generation family. The Christ family shall also be considered as **“VIRGIN TRINITY FAMILY”** composed of THREE-IN-ONE form of members.

- i) **“VIRGIN FATHER”**
- ii) **“VIRGIN MOTHER” (AVE)**
- iii) **“VIRGIN INFANT”**

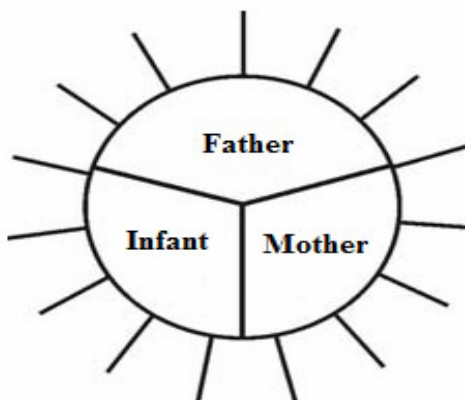

**(Virgin Nathan Family)**

The Father, Mother, Infant shall be considered living in Holy Tabernacle in different chamber separated by a Thin Membrane called **“VEIL”** in absolute peace with **“Closed eye”**.

*AVE Shall mean “VEIL”, “HOLY SPIRIT”*  
*AVE MARY Shall mean “VEIL MARY”*  
*Christ shall mean “family” rather than personal name*

- Author

It is focused by the author that in some Churches during Holy Communion holy foods are prevented to the public and issued only to the confessed people. It is highlighted that **CHRIST FAMILY** shall mean single universal family composed of one flesh and one blood. Christ came to the world to save all irrespective of cast, creed, religion.

- (i) Christ fed fish and loves to the multitude irrespective of cast, creed, religion, denomination. (MAT:14:19)
- (ii) Christ saved the criminals on the cross even the criminal not taken baptism earlier. (LUK:23:43)
- (iii) Christ came to fulfill the law and not to destroy. (MAT:5:17)
- (iv) Christ cured human on Sabbath day (JN: 5:10)

In the history of Biblical Understanding it is focused that **"MANNA"** shall be considered as Holy food created by Nathan from **"Virgin Light"** composed of three fundamental particles PHOTON, ELECTRON, PROTON. Further **"VEIL MARY"** shall be considered as the body of Nathan and J-Radiation shall be considered as blood of Nathan.

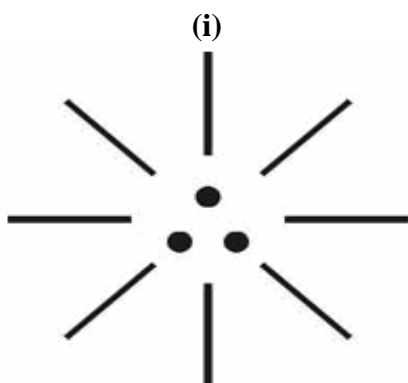

**(MANNA)**

(ii)

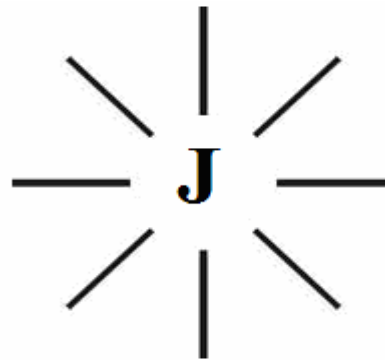

**(NEW COVENANT)**

It is further focused that in the history of evolution of various Churches **"JESUS"** shall be considered as the fundamental "law of life". The fundamental law of life shall also be called as **"CANON"**. The Philosophy of **ROMAN CATHOLIC, SYRIAN CATHOLIC, APOLLO (PROTESTANT)** shall be considered as three distinguished family to the fundamental law of CANON.

- i. CANON – Law of life (Origin)
- ii. Roman Catholic – 1<sup>st</sup> Generation Family
- iii. Syrian Catholic – 2<sup>nd</sup> Generation Family
- iv. Apollo (Protestant) – 3<sup>rd</sup> Generation Family

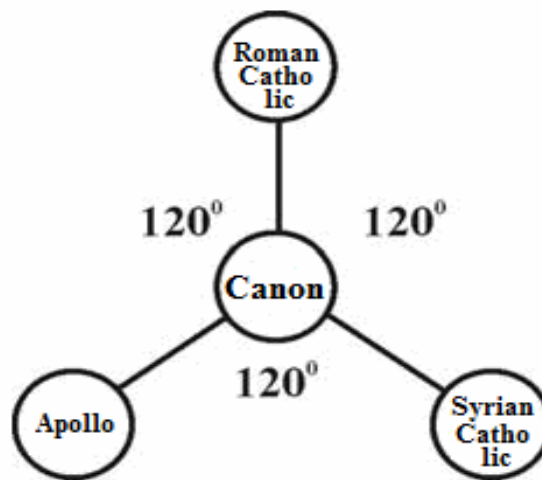

**(Holy J-Temple)**

Further in the history of Geological land, “CANON” shall be considered as the first prehistoric “created land” and the land of Babylon, land of Israel, land of Judah shall be considered as three families of land subsequently evolved from the fundamental land origin Canon. The land of Canon shall also be called as “**HOLY LAND**” within the scope of biblical understanding.

### Conclusion

In the expanding Universe VIRGIN LIGHT shall be considered as the “frame of reference” for attaining “absolute peace”. Further in the expanding universe the speed of light shall be considered consistently reduced minutely everyday due to consistent evolution till end of cosmic universe. The quantum of real peace shall be considered measured within the frame of relative position of “**eye lids**” and heart of human which makes the human to **FLY** at the speed of **VIRGIN LIGHT**.

- (a)Upper Eye lid – Love (Proton)
- (b)Lower Eye lid – Mercy (Electron)
- (c)Heart – Rule (Photon)

### A.Upper Eye lid – Love (Proton)



Infant with closed eye  
(AMEN)

### B.Lower Eye lid – Mercy (Electron)



Child with Opened Eye  
(PEACE)

### C.Heart – Rule (Photon)



Child with Scientific Eye  
(Art of Living Lullaby)

### References

1. Intensive Internet “e-book” study through, Google search and wikipedia
2. M.Arulmani, “3G Akkanna Man”, Annai Publications, Cholapuram, 2011
3. M. Arulmani; V.R. Hemalatha, “Tamil the Law of Universe”, Annai Publications, Cholapuram, 2012
4. Harold Koontz, Heinz Weihriah, “Essentials of management”, Tata McGraw-Hill publications, 2005

5. M. Arulmani; V.R. Hemalatha, "First Music and First Music Alphabet", Annai Publications, Cholapuram, 2012
6. King James Version, "Holy Bible"
7. S.A. Perumal, "Human Evolution History"
8. "English Dictionary", Oxford Publications
9. Sho. Devaneyapavanar, "Tamil first mother language", Chennai, 2009
10. Tamilannal, "Tholkoppiar", Chennai, 2007
11. "Tamil to English Dictionary", Suravin Publication, 2009
12. "Text Material for E5 to E6 upgradaton", BSNL Publication, 2012
13. A. Nakkiran, "Dravidian mother", Chennai, 2007
14. Dr. M. Karunanidhi, "Thirukkural Translation", 2010
15. "Manorama Tell me why periodicals", M.M. Publication Ltd., Kottayam, 2009
16. V.R. Hemalatha, "A Global level peace tourism to Veilankanni", Annai Publications, Cholapuram, 2007
17. Prof. Ganapathi Pillai, "Sri Lankan Tamil History", 2004
18. Dr. K.K. Pillai, "South Indian History", 2006
19. M. Varadharajan, "Language History", Chennai, 2009
20. Fr. Y.S. Yagoo, "Western Sun", 2008
21. Gopal Chettiar, "Adi Dravidian Origin History", 2004
22. M. Arulmani; V.R. Hemalatha, "Ezhem Nadu My Dream" - (2 Parts), Annai Publications, Cholapuram, 2010
23. M. Arulmani; V.R. Hemalatha, "The Super Scientist of Climate Control", Annai Publications, Cholapuram, 2013, pp 1-3